

1 **A** = 90°

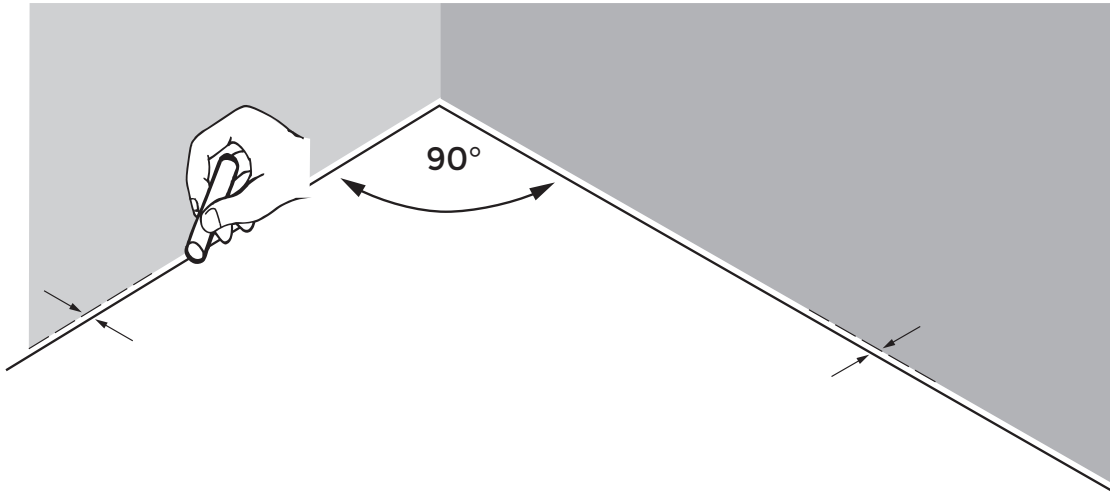

2

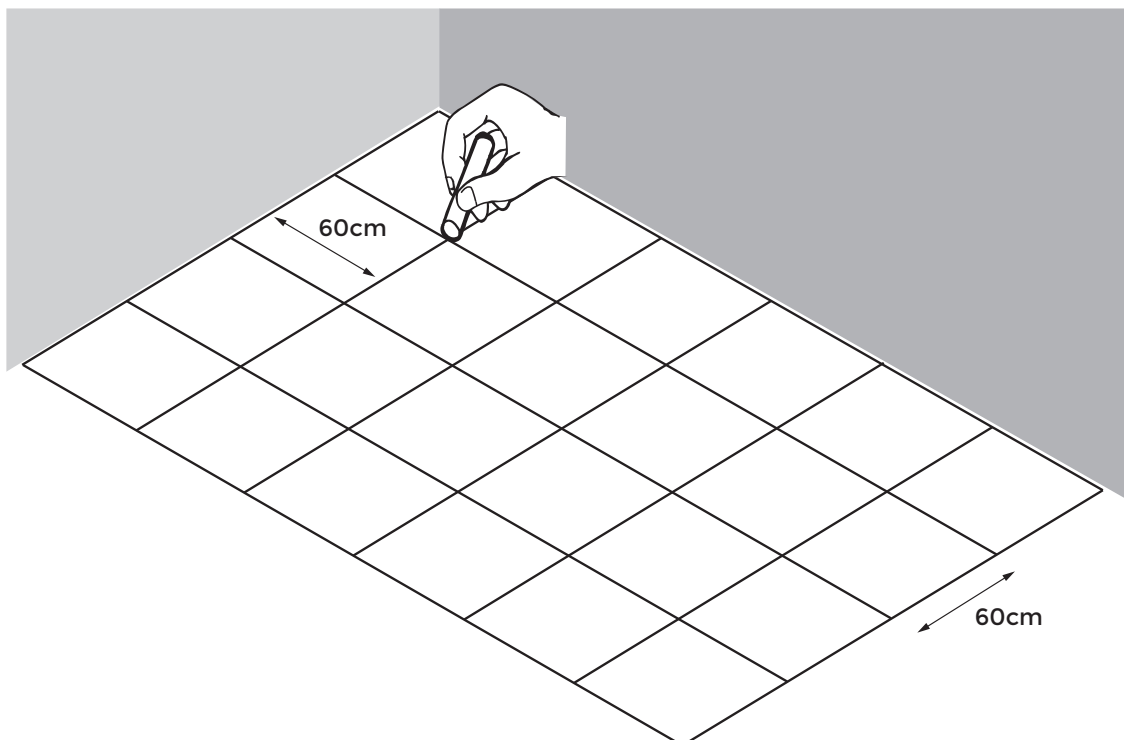

3

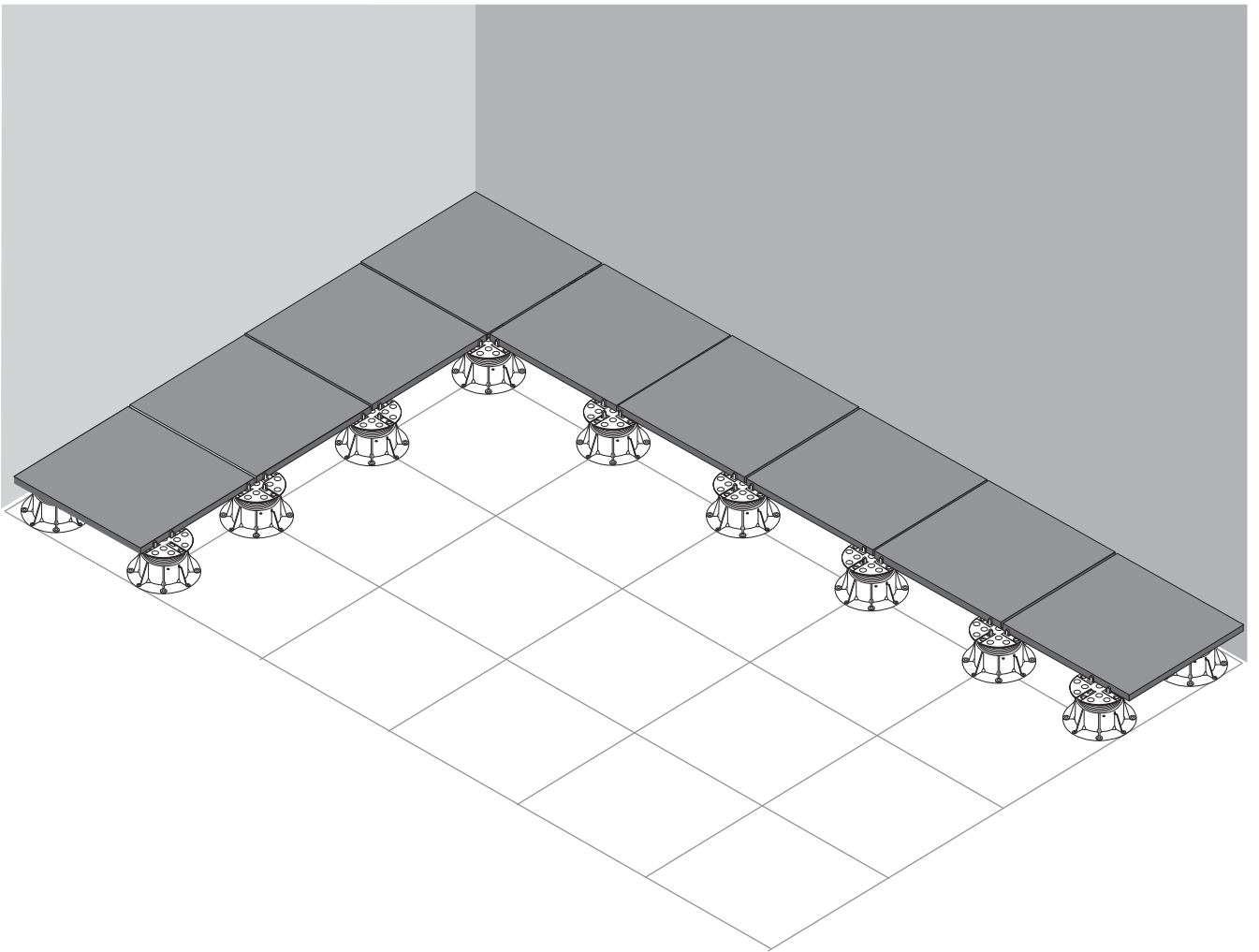
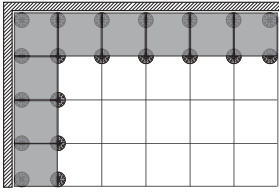

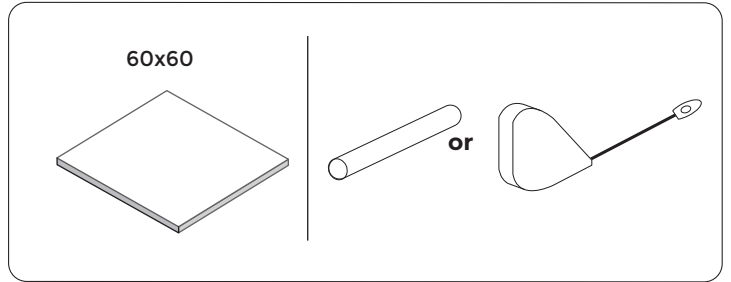
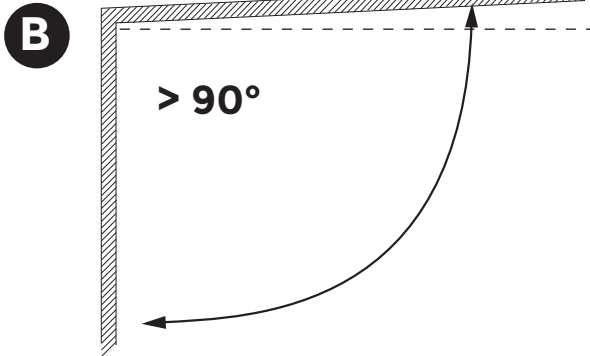

1 **B** > 90°

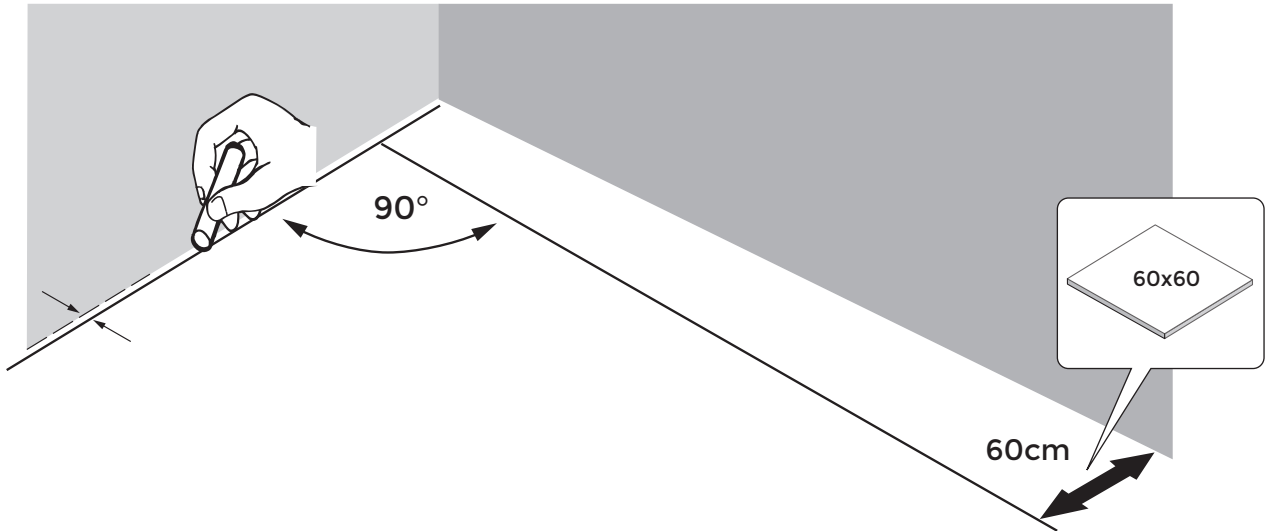

2

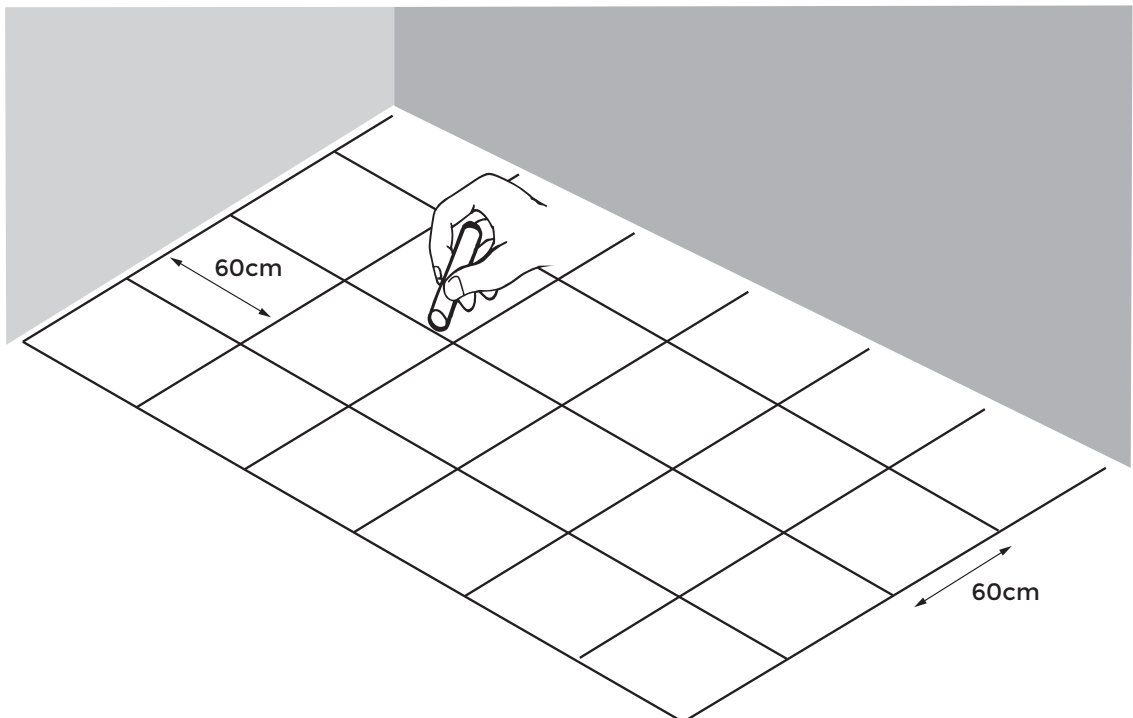

3

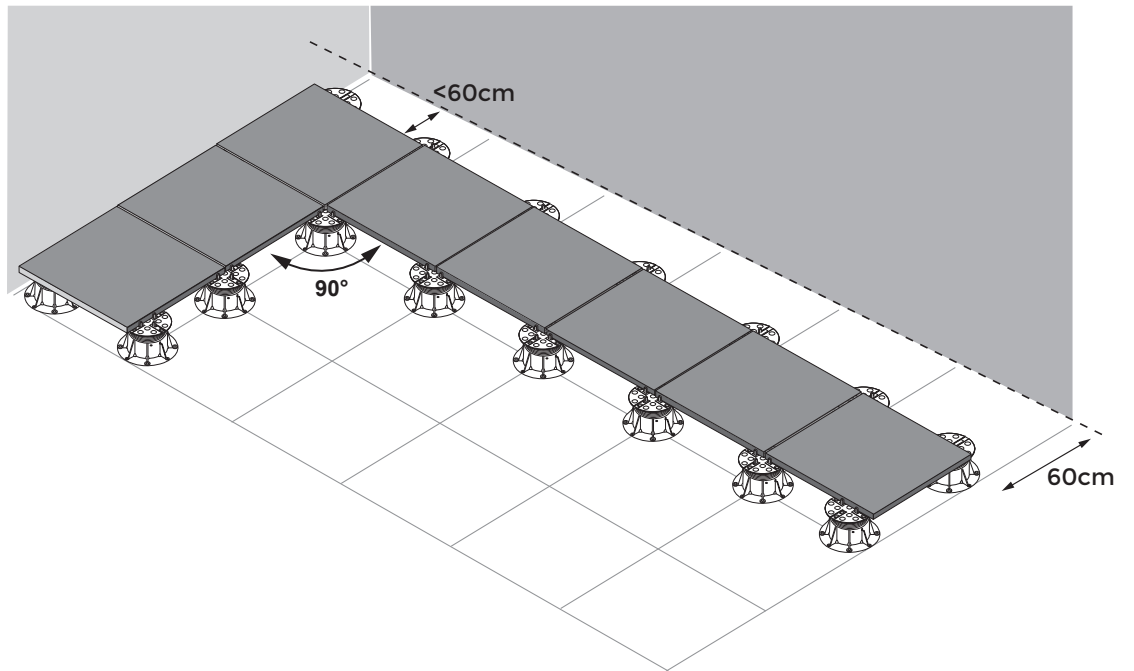
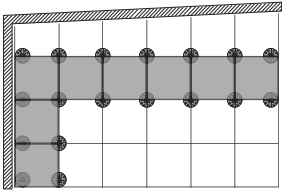

4

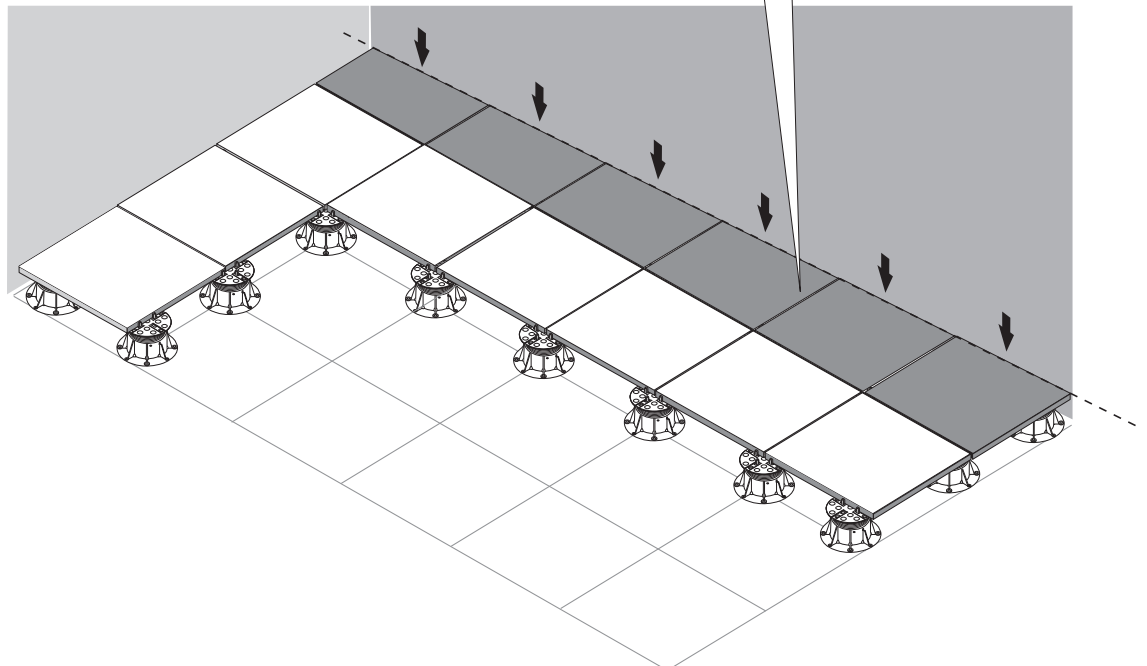
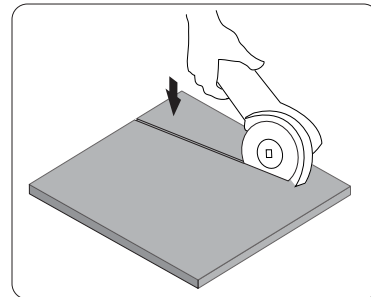
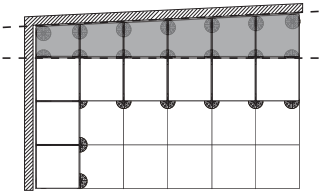

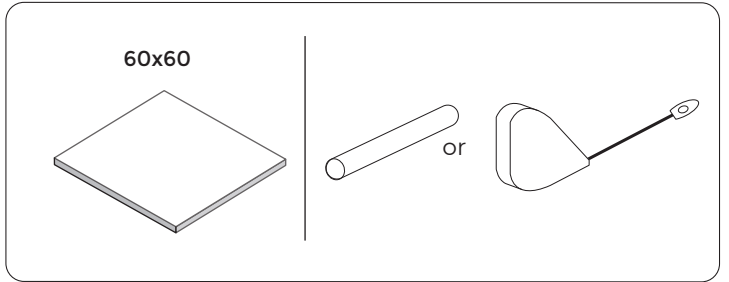
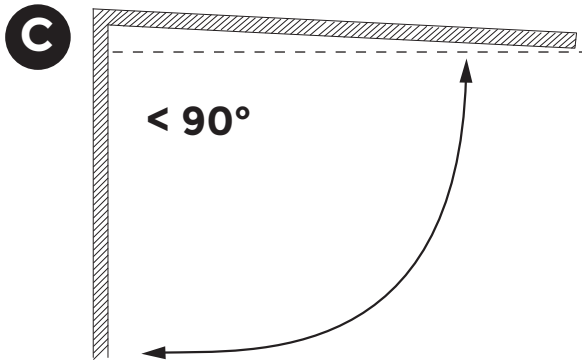

1 **C** $< 90^\circ$

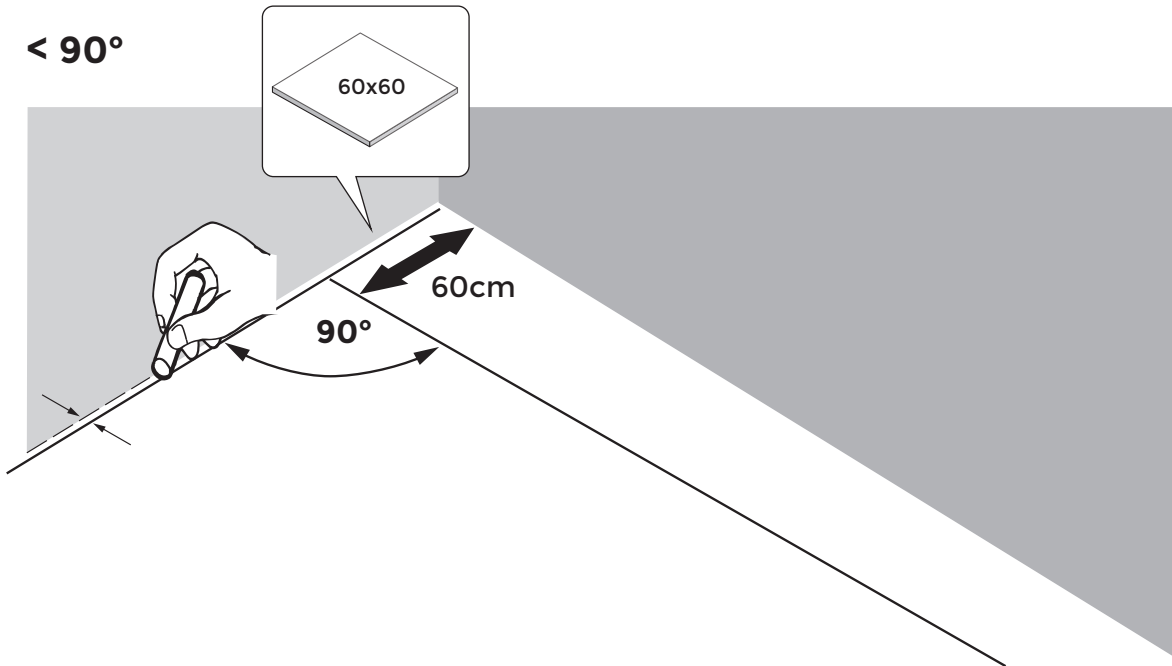

2

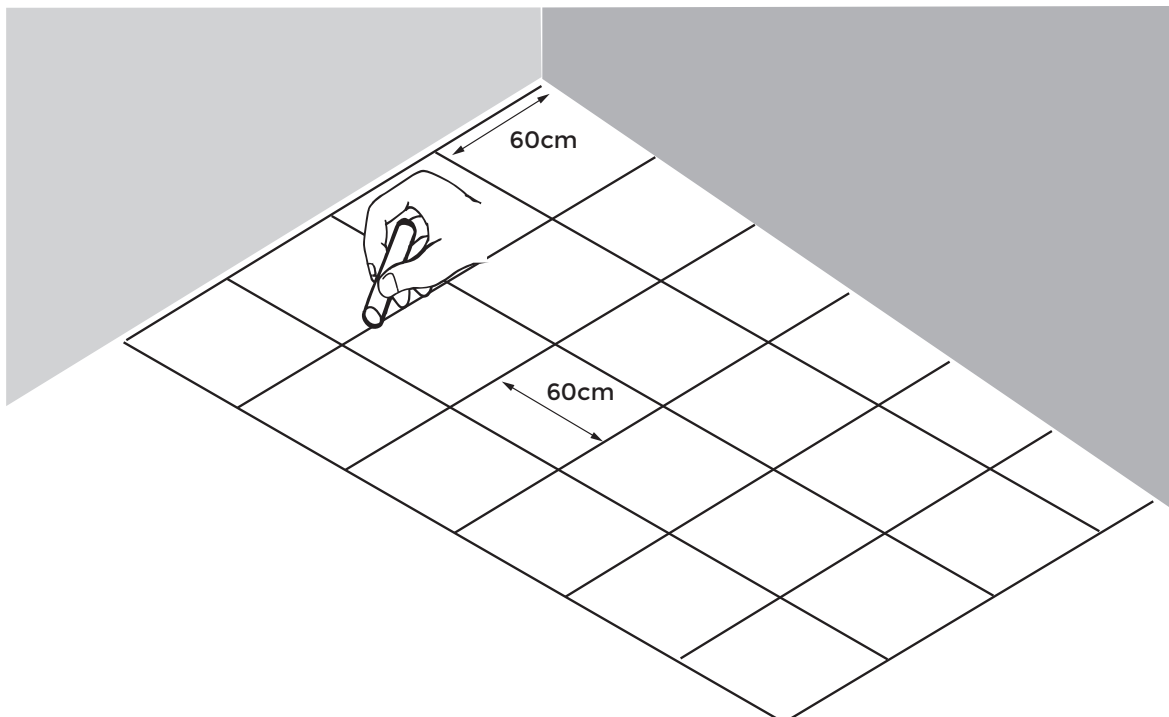

3

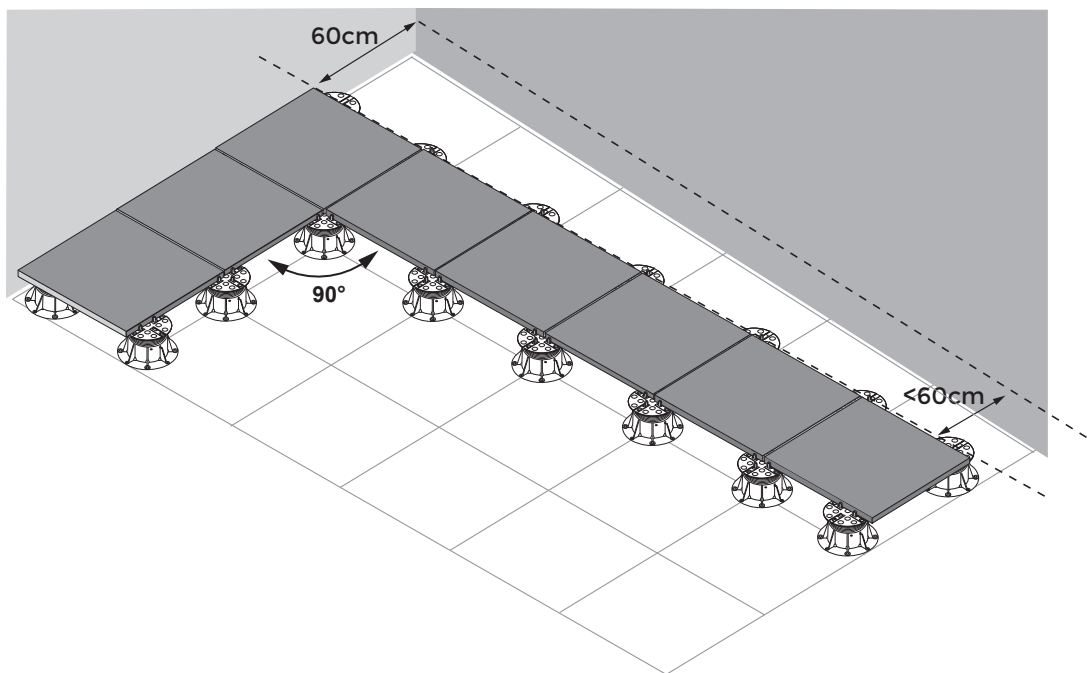
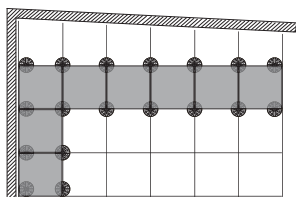

4

